

AIRCRAFT EMERGENCY PROCEDURES

1. RECOMMENDED PROCEDURES FOR ANY EMERGENCY PHASE

1.1 Emergency SSR Codes - EMERGENCY 7700 - RADIO FAILURE 7600

Circumstances	Phraseologies * Denotes pilot transmission
1. Distress message	a.* MAYDAY [MAYDAY, MAYDAY] <i>followed as necessary by:</i> (i) (station addressed) (ii) (aircraft identification) (iii) (nature of distress condition, e.g. FUEL or EMERGENCY DESCENT) (iv) (intentions) (v) (position, level and heading) (vi) (any other useful information).
2. Acknowledgement of distress message ATC acknowledgement of MAYDAY call ATC acknowledgement of MAYDAY on frequency transfer Imposition of radio silence ATC broadcast for emergency descent traffic Cancellation of distress condition Termination of distress and radio silence	a. ROGER MAYDAY b. MAYDAY [(type of emergency)] ACKNOWLEDGED c. STOP TRANSMITTING MAYDAY d. EMERGENCY DESCENT AT (significant point or location) ALL AIRCRAFT BELOW (level) WITHIN (distance) OF (significant point or navigation aid) [LEAVE IMMEDIATELY] [(specific instructions as to direction, heading or track, etc.)] e.* CANCEL DISTRESS (information) f. DISTRESS TRAFFIC ENDED
3. Urgency message ATC acknowledgement of PAN call ATC acknowledgement of PAN on frequency transfer	a.* PAN PAN [PAN PAN, PAN PAN] <i>followed as necessary by:</i> (i) (station addressed) (ii) (aircraft identification) (iii) (nature of the condition e.g. MEDICAL PRIORITY REQUIRED or WEATHER DEVIATION REQUIRED) (iv) (intentions) (v) (position, level, heading) (vi) (any other useful information). b. ROGER PAN c. PAN [(type of emergency)] ACKNOWLEDGED

- 1.1.1 If no answer to distress/urgency, call/message, use the following appropriate frequencies, broadcasting before changing to the next selected frequency.
- Any other aeronautical en route frequency.
 - 121.5 MHz or 243.0 MHz (R/T): International and Military emergency.
 - 5696 USB DCSA HFCS distress frequency.
 - 4125, 6215 and 8291 kHz (R/T, USB): Australian coastal/ship.
 - 3023 and 5680 kHz. World wide A/G frequencies.
 - 2182 kHz (R/T): International small ships. DF available.
- 1.2 **Notification of Emergency Using Datalink**
- 1.2.1 Depending on the nature of the emergency condition experienced, flight crew should notify ATS of the circumstances by the most efficient means (voice or data link).
- 1.2.2 If a CPDLC MAYDAY or PAN message is received by the ground system, the controller will respond with the free text uplink message ROGER MAYDAY (PAN). The controller will not expect a ROGER response to the uplink until being notified that the emergency situation has been cancelled or stabilised to the extent that messages are able to continue being exchanged (if data link is considered to be the best communications medium for the situation).
- 1.2.3 If the emergency situation no longer exists, the pilot should cancel the ADS emergency mode (if activated).
- 1.3 **Imposition of Silence**
- 1.3.1 Only the ACFT in distress or the unit in control of distress communications is permitted to impose silence on any station which interferes with distress communications. The call should be addressed to ALL STATIONS or one station only, depending on circumstances. The call should be as follows:
"STOP TRANSMITTING; MAYDAY"
- 1.4 **Alerting Surveillance Unit (MIL OPS only)**
- 1.4.1 If in an emergency within coverage of a surveillance unit and unable to make radio contact with any ATS unit and outside civil controlled airspace, the surveillance unit can be alerted as follows:
- Switch transponder to emergency, squawk mode 3A, code 7700.
 - Continue attempts to make communications and monitor the appropriate frequencies (see communications failure instructions for appropriate frequencies).
- 1.4.2 Fly applicable pattern shown below.

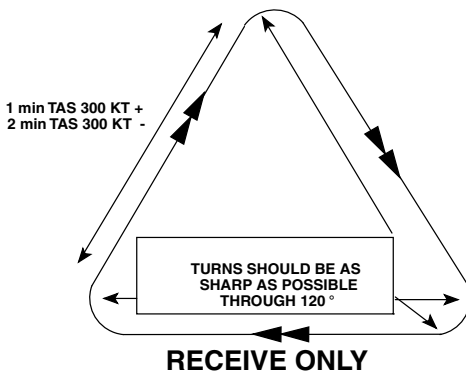

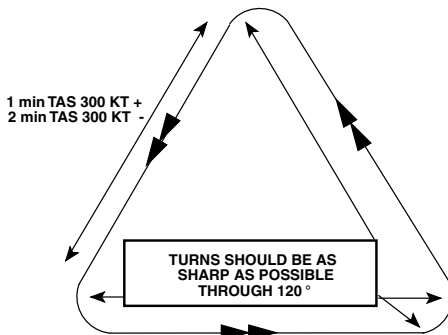

NO TRANSMIT OR RECEIVE

- 1.4.3 If adopting this procedure:
- fly at best endurance speed;
 - complete at least two patterns before resuming heading;
 - make turns as tight as practicable;
 - attempt to maintain VMC to facilitate interception by a shepherd aircraft; and
 - at night or in VMC, turn on navigation and anti-collision lights.
- 1.5 **Communication Failure**
- 1.5.1 In the event of communications failure, maintain terrain clearance throughout all procedures.
- 1.5.2 **Indications by an Aircraft:**
- In Flight
 - during the hours of daylight - by rocking the aircraft's wings; and
Note: This signal should not be expected on the base and final legs of the approach.
 - during the hours of darkness - by flashing on and off twice the aircraft's landing lights or, if not so equipped, by switching on and off twice its navigation lights.
 - On the Ground
 - during the hours of daylight: by wagging the aircraft's ailerons or rudder; and
 - during the hours of darkness: by flashing on and off twice the aircraft's landing lights or, if not so equipped, by switching on and off twice its navigation lights.
- 1.5.3 **If VFR in Class G Airspace**
- Remain in VMC.
 - Broadcast Intentions (assume transmitter is operating and prefix calls with "TRANSMITTING BLIND").
 - Remain VFR in Class G airspace and land at the nearest suitable aerodrome.
 - Report arrival to ATS if on SARTIME or reporting schedules (SAR telephone number: 1800 815 257).
- 1.5.4 **If in Controlled/Restricted Airspace or if IFR in any Airspace:**
- Squawk 7600
 - Listen out on ATIS and/or voice modulated NAVAIDs.
 - Transmit intentions and make normal position reports (assume transmitter is operating and prefix calls with "TRANSMITTING BLIND").
- AND**
- if in VMC and are certain of maintaining VMC
- Stay in VMC and land at the most suitable aerodrome (note special procedures if proceeding to a Class D).
- OR**
- If in IMC or are uncertain of maintaining VMC
- If no clearance limit received and acknowledged, proceed in accordance with the latest ATC route clearance acknowledged and climb to planned level.

- f. If a clearance limit involving an altitude or route restriction has been received and acknowledged:
 - (i) maintain last assigned level, or minimum safe altitude if higher, for three (3) minutes, and/or
 - (ii) hold at nominated location for three (3) minutes, then
 - (iii) proceed in accordance with the latest ATC route clearance acknowledged, and climb to planned level.
- g. If receiving an ATS surveillance service:
 - (i) climb to MSA/LSALT, and,
 - (ii) if being vectored, maintain last assigned vector for two (2) minutes, then
 - (iii) proceed in accordance with the latest ATC route clearance acknowledged.
- h. If holding:
 - (i) fly one more complete holding pattern, then
 - (ii) proceed in accordance with the latest ATC route clearance acknowledged.

Notes:

1. *Initial and subsequent actions by the pilot at the time of loss of communications will depend largely on the pilot's knowledge of the destination instrument approaches, the air traffic/airspace situation and meteorological conditions en route and at the destination. Publishing procedures that cover all radio failure circumstances is not possible. The above procedures ensure that ATS and other traffic should be aware of the pilot's **most likely actions**. Pilots should follow these procedures unless strong reasons dictate otherwise.*
2. *In determining the final level to which a pilot will climb after radio failure, ATC will use the level provided on the flight notification, or the last level requested by the pilot and acknowledged by ATC.*

1.5.5 **Destination Procedures:**

- a. Track to the destination in accordance with flight plan (amended by the latest ATC clearance acknowledged, if applicable).
- b. Commence descent in accordance with standard operating procedures or flight plan.
- c. Descend to the initial approach altitude for the most suitable instrument approach in accordance with the published procedures.
- d. Carry out the approach to the prescribed minima.

Notes:

1. *The most suitable approach is normally the approach that facilitates the most accurate track keeping, however, if the pilot is in receipt of ATIS or directed information (e.g. voice modulated navigation aid) that a specific approach is required, that approach should be used.*
2. *If an approach time has been given by ATC and acknowledged, adhere to this time.*
3. *When within 25NM of the destination, the pilot may track direct to the IAF for the most suitable approach.*
4. *At Sydney during Independent Visual Approaches, refer to Sydney/Kingsford Smith entry in FAC section.*

1.5.6 **Actions at Minima**

- a. If visual at the minima at an uncontrolled aerodrome, continue to land provided that a safe landing can be accomplished. If visual at the minima at a controlled aerodrome continue to land provided that a clearance to land is received via a voice modulated NAVAID and/or light signal from the Tower.
- b. If not visual at the minima, depart for a suitable alternate aerodrome.
- c. If insufficient fuel is carried to divert to a suitable alternate, the pilot may hold or carry out additional approaches until visual.
- d. Certain Class D aerodromes have specific communications failure procedures which are shown at each aerodrome entry in the FAC section

LIGHT SIGNAL	Meaning to ACFT in Flight	Meaning to ACFT on Airfield
STEADY GREEN	Authorised to land if pilot satisfied no collision risk exists	Authorised to takeoff if pilot satisfied no collision risk exists
STEADY RED	Give way to other aircraft and continue circling	Stop
GREEN FLASHES	Return for landing	Authorised to taxi if pilot satisfied no collision risk exists
RED FLASHES	Airfield unsafe - do not land	Taxi clear of landing area in use
WHITE FLASHES	No significance	Return to starting point on airfield

1.6 Speechless Radar Approach Procedures

Situation	Transmission
1 Pilot request for Speechless Radar approach when microphone/s are unserviceable (carrier wave only available).	Pilot transmits four (4) separate and distinct unmodulated transmissions of one second duration
2 Pilot responses to subsequent control questions: A. affirmative or acknowledgment, B. negative, C. say again	A. one distinct transmission B. two separate and distinct transmissions C. three separate and distinct transmissions
3 Pilot indication of a further and pertinent unserviceability or an emergency	Five (5) separate and distinct transmissions
4 Pilot indication of abandoning the aircraft	A single continuous transmission as long as practicable. Where possible the transmitter key is to be locked on.
5 Controller requires pilot to indicate when an instruction has been completed	WHEN (condition or instruction is completed) MAKE A TWO SECOND TRANSMISSION

1.6.1 Communication and NAVAID Failure

In the event of complete failure of communications and NAVAIDs, maintain terrain clearance and proceed as follows:

- a. If VFR in Class G Airspace
 - (i) Remain VMC.
 - (ii) Broadcast intentions (assume transmitter is operating and prefix calls with "TRANSMITTING BLIND").
 - (iii) Remain VFR in Class G airspace and land at the nearest suitable aerodrome.
 - (iv) Report arrival to ATS if on SARTIME or reporting schedules.
- b. If in Controlled / Restricted Airspace or if IFR in any Airspace:
 - (i) Squawk 7600.
 - (ii) Listen out on ATIS and/or voice modulated NAVAIDs.
 - (iii) Transmit intentions and normal position reports (assume transmitter is operating and prefix calls with "TRANSMITTING BLIND"). if practicable, leave/avoid controlled/restricted airspace and areas of dense traffic.
 - (iv) As soon as possible, establish visual navigation.
 - (v) Land at the most suitable aerodrome (note special procedures if proceeding to a Class D - see above).
 - (vi) Report arrival to ATS.

1.7 Emergency Change of Level in Controlled Airspace

1.7.1 When an aircraft in controlled airspace is required to make a rapid change of flight level or altitude because of technical trouble, severe weather conditions, or other reasons, the change will be made as follows using urgency message format, stating level changes involved and diversions, if applicable:

- a. Squawk SSR Code 7700.
- b. Transmit: PANPAN, PANPAN, PANPAN, then
 - (i) agency being called,
 - (ii) aircraft identification;
 - (iii) nature of urgency problem;
 - (iv) intention of person in command;
 - (v) present position, flight level or altitude and heading; and
 - (vi) any other useful information.

1.8 Pre/Post Impact Actions

1.8.1 The following actions should be carried out pre-impact:

- a. Activate Crew Impact Instruction. If no prescribed drill, check:
 - (i) preparation of aircraft for impact;
 - (ii) positioning of personnel;
 - (iii) activate ELT (see separate section following);
 - (iv) crew procedure for directing evacuation of aircraft in orderly manner; and
 - (v) ready availability to crew members of charts showing emergency and distress communication facilities; i.e. location, callsign, frequency of:
aeronautical stations;
DF stations; and
coast radio stations guarding international distress frequencies.
- b. Instruct passengers that they will be required to
 - (i) recognise the absolute authority of the pilot in command;
 - (ii) apply safety apparatus as instructed;
 - (iii) prepare for impact shock as instructed;
 - (iv) don protective clothing;
 - (v) make an orderly exit from the aircraft; and
 - (vi) remain near the aircraft after the evacuation (at sea, secure life rafts and set sea anchor).

1.8.2 Immediately prior to impact, set radio apparatus for continuous operation unless the additional risk of fire is too great.

1.8.3 The following should be carried out post-impact:

- a. Activate post impact instructions.
- b. If no prescribed drill, check the following:
 - (i) account for all personnel;
 - (ii) account for all distress facilities;
 - (iii) tend to the injured;
 - (iv) try to attract attention (radio, flares, smoke, mirrors, etc.);
 - (v) display appropriate visual rescue signals;
 - (vi) keep personnel together;
 - (vii) utilise passenger resources, i.e. skill, knowledge, effort, etc.;
 - (viii) delegate duties as equitably as possible;
 - (ix) conserve resources, i.e. water, food, manpower, facilities;
 - (x) maintain passenger morale; and
 - (xi) ensure ELT is activated.
 - (xii) collect all food/water and useful equipment from the aircraft.

1.9 Inadvertent Activation of Emergency Locator Transmitter (ELT)

1.9.1 If the ELT has inadvertently been activated for more than 10 secs contact SAR on 1800 815 257.

1.10 Activation of ELT

1.10.1 An Emergency Locator Transmitter (ELT) is a valuable search aid if an aircraft is forced down. However, to obtain maximum benefit from the beacon and to assist search aircraft, pilots need to observe a few guidelines for activation of the ELT.

- 1.10.2 If in water and the beacon is buoyant, the ELT should be activated in the water and allowed to float to the end of the lanyard with the aerial vertical. Do not hoist the ELT up a mast. The performance of an ELT may be degraded if it is raised above the water surface.
- 1.10.3 Lives may depend on the correct use of the ELT. The manufacturer's instructions should be studied thoroughly, and kept in the aircraft emergency kit.
- 1.10.4 If you are forced down the following procedure is recommended:
- Activate the ELT immediately;
 - Where the ELT is permanently installed in the aircraft, activate the beacon *in situ*;
 - Where the ELT is not permanently installed in the aircraft, select an elevated site clear of trees, boulders etc. and reasonably close to the aircraft.
 - Place the beacon on the ground on an earth mat. If an earth mat is not available, place the ELT on the wing of the aircraft or another metal reflective surface.
 - Secure the ELT with rocks, sticks, tape etc. so that the aerial will remain vertical. avoid anything touching the antennae as this will degrade ELT performance.
 - Remain clear of the ELT. Obstacles near the ELT will distort the radiation pattern.
 - An ELT which is damaged or under wreckage may still transmit some signal. (Always activate the ELT).
 - Do not switch off the ELT unless rescue is no longer required.**
 - To avoid confusing COSPAS/SARSAT and direction finding equipment, avoid activating two or more ELTs within 1NM of each other.

Note: In many cases, using an earth mat will increase the effective range of a portable ELT by 50%. A simple and effective earth mat can be made by using household aluminium foil to make a 120CM square, folded, and taped to the unit. To use the earth mat, unfold and place it flat on the ground, securing edges with dirt or rocks. Activate the ELT and place it on the mat.

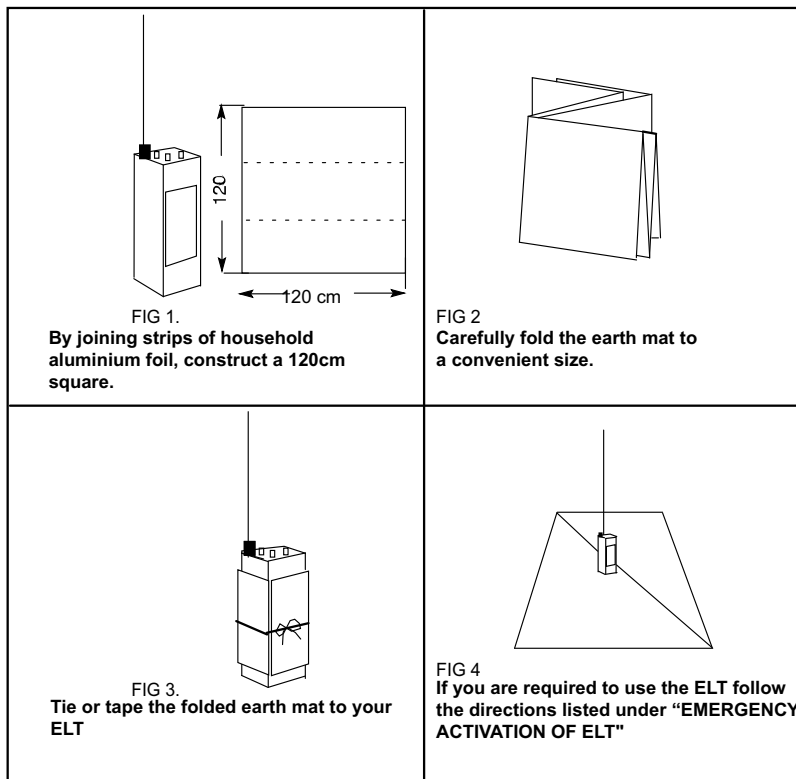

1.11 ELT Characteristics

1.11.1 The following characteristics pertain to ELTs:

- a. Frequency 406 MHz (digital) and 121.5 MHz (analog) and, in some instances, 243 MHz.
- b. 121.5 and 243MHz modulation.
 - (i) continuous carrier continuously modulated at the rate of three swept tones per second, no pauses;
 - (ii) some older marine beacons transmit the carrier on for one second then off for one second, modulation three swept tones per second. This results in the tones being received in evenly spaced groups of three with a distinct one-second pause between groups; and
 - (iii) some foreign marine beacons vary from the above; e.g. there is a European beacon pulsing in groups of two tones.

1.12 Reports

- a. report all beacons received;
- b. state characteristics;
- c. when giving signal heard/strength fade positions, include ACFT level and squelch disabled (MAX hash) information. This is necessary for plotting;
- d. advise if signal commenced/ended gradually or abruptly; and
- e. do not alter squelch setting unless requested.

Note: Rescue Co-ordination Centres can demonstrate the above signals on request.

2. AIR SEARCH PATTERNS

2.1 General

2.1.1 This section is included to assist pilots of aircraft engaged in air search operations. The information is necessarily brief and the SAR Centre recommends that a full preflight briefing be obtained whenever time and/or circumstances permit.

2.2 Visual Search

2.2.1 Visual search patterns are divided into six main groups, which are described briefly below. In the diagrams "S" represents track spacing, i.e, the distance in nautical miles between successive tracks flown by the search aircraft and will be specified by the RCC as part of the briefing or by the assessed visual range of the day.

a. **Trackline Search-** (See *DIAGRAM 1*)

- (i) A trackline pattern is most often used in an initial reaction.
- (ii) It is very suitable for use by an aircraft available at, or near, the time of a reported distress.
- (iii) The assumptions made are that survivors will be found on, or close to, the planned route of the missing craft, that the distressed craft is easily discernible, or that survivors will be capable of signalling should an aircraft be seen or heard.
- (iv) It provides a rapid and reasonably thorough coverage of a missing craft's planned route, and the immediately adjacent area.

SEARCH OBJECT'S TRACK LINE

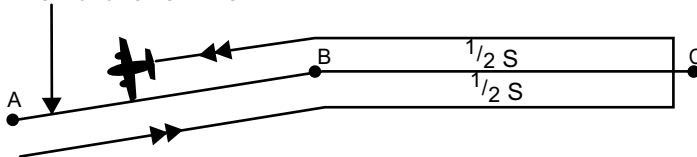

SEARCH OBJECT'S TRACK LINE

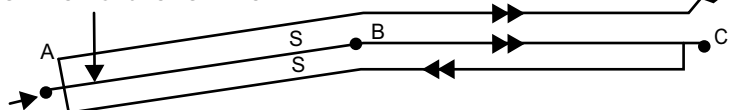
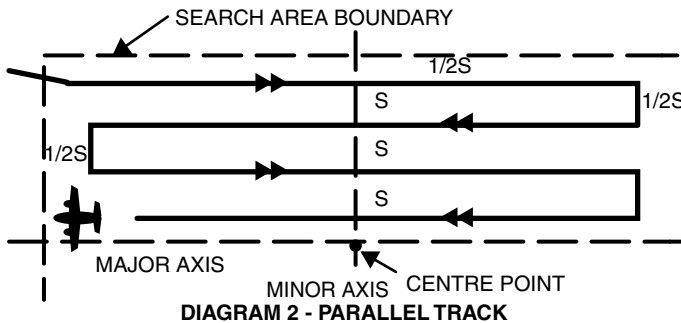

DIAGRAM 1 - TRACKLINE PATTERN

b. **Parallel Track Search-** (See *DIAGRAM 2*)

- c. Search legs are aligned parallel to the major axis of the search area.

- d. The pattern is best used in rectangular or square areas.
- e. This pattern is very suitable for a search conducted over water.



f. **Creeping Line Search-** (See *DIAGRAM 3*)

- (i) The creeping line pattern differs from the parallel track pattern in that the search legs are parallel to the minor axis.

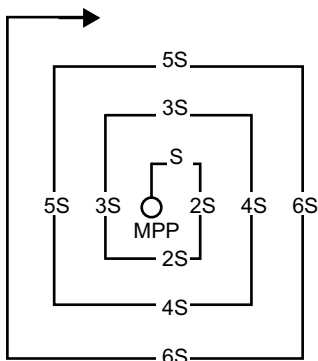
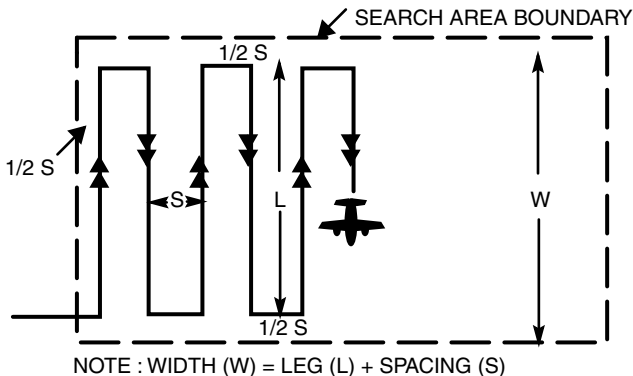

- g. **Square Search-** (See *DIAGRAM 4*)
- The aircraft is flown to make good the tracks shown in the diagram.
 - Turns may be to the left, or right, depending upon the observer positions.
 - The first two tracks are flown for a distance equal to "S", the third and fourth for a distance equal to twice "S", the fifth and sixth for $3 \times S$, and so on.
 - The final track to the start point should be the same as the initial search track.
 - Observations should start at a distance of "S" before reaching the most probable position to avoid leaving an unscanned portion near the start point.
 - Observers should be briefed to pay particular attention to the scanning of the areas outwards of each turn to avoid leaving unscanned areas during the turns.
 - A square search should be planned so that, whenever possible, the approach to the most probable position (MPP), and the first leg, is made into wind.
- h. **Sector Search-** (See *DIAGRAM 5*)
- This pattern is employed when the position of distress is known within close limits and the area to be searched is not extensive.
 - It is simple to execute and provides greater navigational accuracy than a square search.
 - The track spacing reduces towards the centre, resulting in a greater probability of detection in the area where the target is most likely to be located.
 - Radius of search, angular displacement and mean track spacing (MTS) are specified with the briefing.

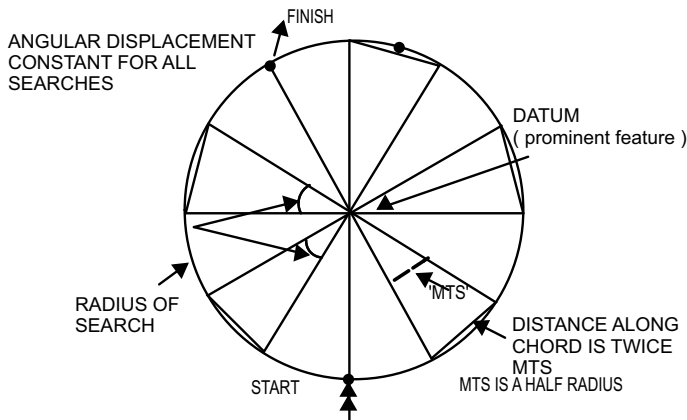

DIAGRAM 5 - SECTOR SEARCH

- i. **Contour Search-** (See *DIAGRAM 6 AND DIAGRAM 7*)
- 2.2.2 This procedure requires an aircraft to be flown at selected contour levels, adjacent to the side of the mountain, starting at the highest selective level.

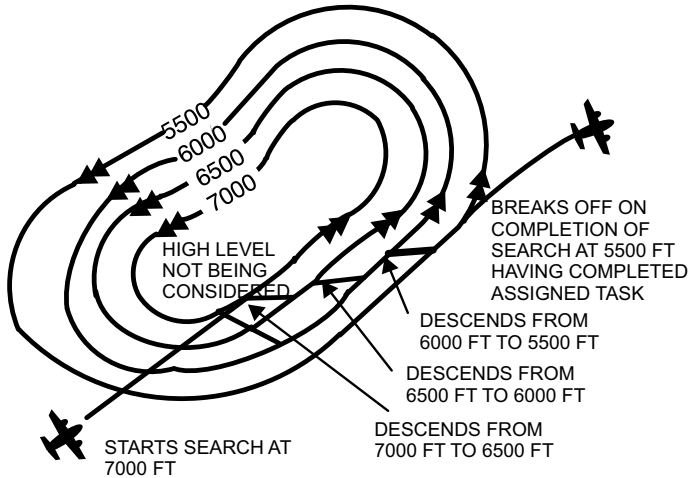

DIAGRAM 6 - CONTOUR SEARCH (PLAN VIEW)

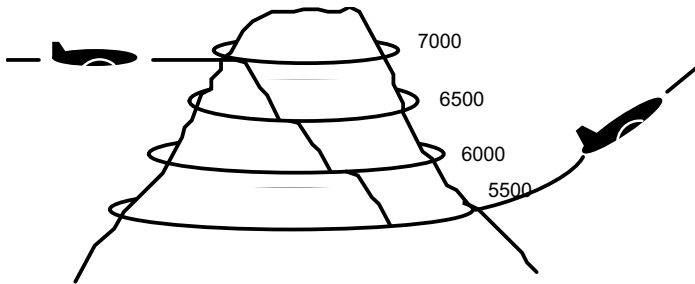
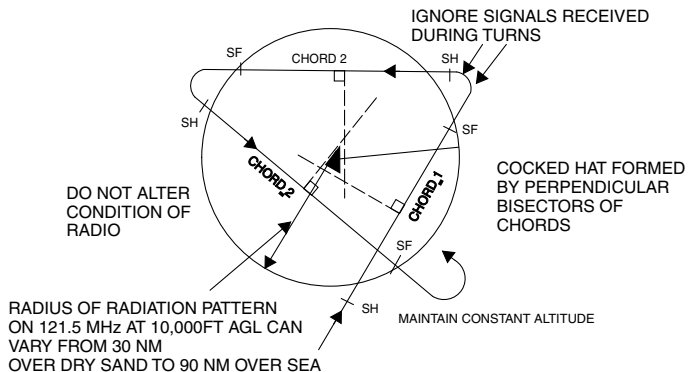

DIAGRAM 7 - CONTOUR SEARCH

2.3 Electronic Search - (See DIAGRAM 8)



- 2.3.1 Electronic searching is used to search for survivors who may have activated a VHF (or VHF/UHF) locator transmitter. An aircraft equipped with a VHF receiver may locate a survival transmitter using procedures which are based on the assumption that an undistorted radiation pattern is approximately circular. A searchmeter may be used to assist a search operation and is basically a signal strength meter which can be plugged into an aircraft VHF receiver.
- 2.3.2 The following procedures should be used during initial aural search without a searchmeter:
- Set the aircraft receiver to its most sensitive condition-squelch disabled;
 - Note and report the position at which the signal is first heard (SH) and fades (SF) and do not change altitude or the condition of the radio;
 - After the signal has faded select a heading estimated to take the aircraft through the radiation pattern, but ignore any beacon signals received during the turn; and
 - Continue chording the radiation pattern until it is possible to establish a cocked hat for the probable position of the beacon, (See *Diagram 8*).
- 2.4 **Carry out a final homing (See DIAGRAM 9).**

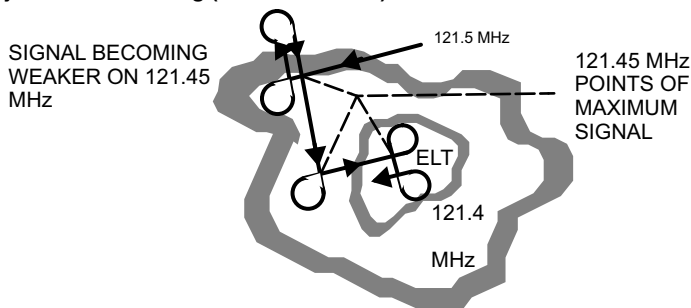

DIAGRAM 9 - FINAL HOMING

- 2.4.1 The final homing procedures without a searchmeter are:
- Track towards the estimated centre of the radiation pattern.
 - Set the aircraft receiver to its most sensitive condition and descend, if possible, to be between 1000 and 2000 feet above ground level in the estimated centre. When the signal from the beacon is very strong and very clear, check on the adjacent frequencies of 121.45 or 121.55 MHz;
 - Traverse the area bounded by the cocked hat, listening for the beacon on the adjacent frequency;
 - On hearing the signal on the adjacent frequency, select and fly a heading which results in a stronger signal. As the signal increases in strength, check further off frequency and descend as required.
- At this stage it is most important that each track should be a straight line. Helicopter pilots should avoid any tendency to orbit a suspected site;*
- The accuracy of the homing will usually depend upon how far off frequency the signal can be heard. Observers will find that a signal being received on, for example, 121.3 or 121.7 MHz (over land) will rise to a sharp peak only as the search aircraft passes over the beacon site at 500FT above ground level. Where the terrain is heavily timbered (e.g. rain forest,), helicopter pilots should descend to lower levels and tune further off frequency to achieve greater accuracy. Information gained during straight and level flight only is most important and is the only data that should be used.*
- Where the signal is irregular, it is usually because the beacon is located amongst obstacles such as trees, rocks, wreckage, etc. The resultant radiation pattern is no longer circular and the signal heard/signal fade principles no longer apply.*
- 2.4.2 The following procedures should be used during aural search with a searchmeter:
- Set the aircraft receiver to its most sensitive condition-squelch disabled.
 - Plug the searchmeter into the SAR outlet.
 - Fly as high as practicable for aircraft type and weather conditions.
 - On receiving the emergency signal, advise the Rescue Co-ordination Centre (RCC) of position, heading and indicated airspeed.

- e. The radiation pattern from a beacon can either be approximately circular (regular) or lobular (distorted). Where the signal received from the beacon is constant the following procedures should be used:
- (i) Fly a heading which will result in an increase in the reading on the search meter. Maintain this heading at a constant altitude and airspeed (*See DIAGRAM 10*).

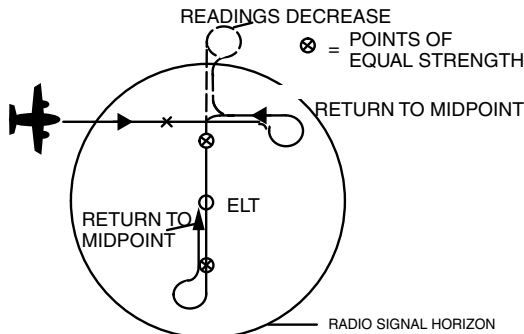

DIAGRAM 10 - SEARCHMETER PROCEDURES

- (ii) Note the time and aircraft position at each half division on the searchmeter.
- (iii) Continue (i) until readings on the searchmeter decrease. Select two positions of equal reading and return to the midposition.
- (iv) On arriving at the midposition turn 90DEG and note the readings on the search meter. If the meter readings decrease turn 180DEG and proceed to determine two further positions of equal signal strength then return to the mid-position.
- (v) When apparent that the beacon is close, descend, if possible, to an altitude giving approximately 2000FT clearance above terrain within approximately 10NM of the search aircraft.
- (vi) By continuing the boxing-in technique the observer should be able to estimate the position of the beacon to within an area of 24 square miles.
- (vii) The beacon site may be located with greater accuracy by detuning the VHF receiver to 121.45 or 121.4 whilst close to the beacon and noting the position on the ground over which there is maximum searchmeter deflection. The receiver may also be detuned to 121.55 or 121.6. With the search aircraft 500FT above ground level and the receiver tuned to 121.3 or 121.7, the signal will only be heard within 200-300 metres of the beacon site (*See DIAGRAM 11*).

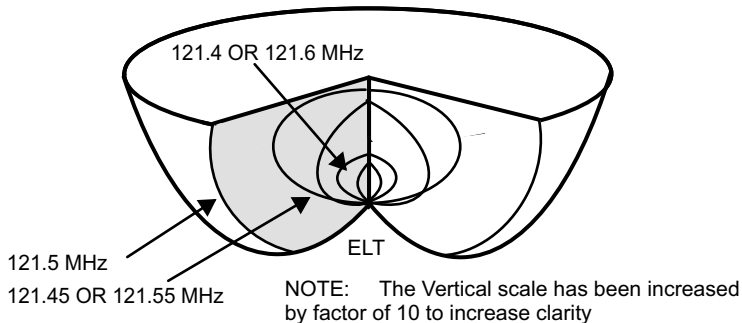
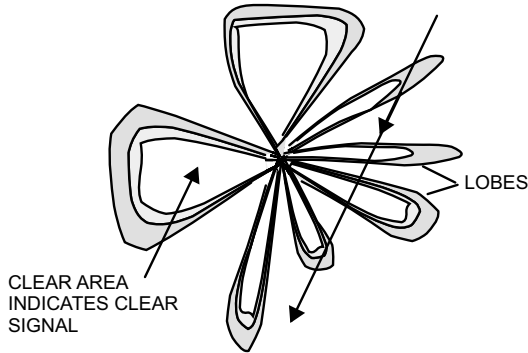

DIAGRAM 11 - DETUNING PATTERN



INTENSITY OF STIPPLING INDICATES AMOUNT OF BACKGROUND HASH

DIAGRAM 12 - DISTORTED RADIATION PATTERN

Note: Where the signal from the beacon is broken and distorted, the most probable cause is that the beacon is amongst obstacles such as wreckage, trees, rocks, etc. which cause the signal to be absorbed or reflected, forming lobes.

With the search aircraft flying along the track indicated in Diagram 12, the searchmeter needle would rise and fall, corresponding with the passage of the aircraft through successive lobes where the signal could be heard. In between the lobes there would be receiver noise and no signal. Provided the aircraft is several thousand feet above terrain, the observer may assume that the signal is being received direct from the beacon rather than by reflection from surrounding terrain. Thus by following a lobe the search aircraft will be guided direct to the beacon, (See DIAGRAM 13).

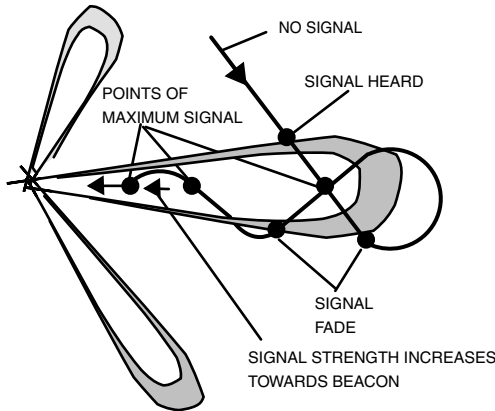

DIAGRAM 13 - INTERCEPTING A LOBE

- f. When the ratio between the beacon signal and the background hash begins to favour the latter, alter heading until only a clear signal can be heard. The signal from the beacon should be continuous with clarity improving as the search aircraft approaches the beacon.
- g. Once a heading has been established, note the searchmeter readings. The readings will increase as the aircraft approaches the beacon site, reaching a maximum when about to overfly. The position of the beacon may be located with greater accuracy by progressively detuning the VHF receiver to 121.3 or 121.7MHz.

2.5 Overwater Searches

- 2.5.1 The principles of an overwater search using a searchmeter are similar to those used for a regular pattern. However, the following differences should be noted:
- The radiation pattern from a beacon transmitting overwater will generally be much larger than if the beacon were on land. This could be up to 90NM to an aircraft flying at 10000FT, and 180NM at 30000FT.
 - Some older marine beacons have an interrupted carrier.
 - Where a search aircraft is operating at an altitude of 10000FT or less and has a searchmeter reading of more than four, the pilot should check on the adjacent frequency of 121.45 or 121.55. If the signal can be heard on that frequency, albeit faintly, the search aircraft will be within 15 NM of the beacon.

2.6 Mountainous Terrain

- 2.6.1 A beacon which is activated in mountainous terrain may be likened to an electric light bulb illuminated in a model of the same area. The pilot of an aircraft flying in areas where the light is reflected would be able to receive signals which are reflected. From positions where the light could be seen direct, signals would be received directly from the beacon or, conversely, where there were no reflections and the light could not be seen, there would be no signals. Signals radiating from a beacon in rough country are absorbed, reflected and reinforced to form isolated patches of strong signal which tend to hinder rather than assist the location of the beacon.
- 2.6.2 To avoid possible confusion from reflected signals, it is essential that the search aircraft should conduct a homing from an altitude above all terrain in the general area. This does not apply to search aircraft flying in valleys or behind mountains in order to ascertain where the beacon signal cannot be heard.

3. SEARCH AND RESCUE SIGNALS

3.1 Third Party Emergency Reporting

- Remain in the vicinity or as directed otherwise and keep the aircraft, surface craft or distressed personnel in sight.
- Turn on automatic emergency radio equipment unless:
 - accurate position fixing is possible, and
 - two way communications exist with ATS.
- Report the following information as applicable to the responsible ATS:
 - TYPE** of aircraft or surface craft;
 - LOCATION** of distress incident in latitude and longitude, geographical point or bearing and distance from some fixed point; and
 - DETAILS** regarding the number of personnel concerned, whether known to be afloat and the apparent physical condition of survivors.
- Alert coast and ship stations by transmitting on international distress frequencies 2182, 4125, 6215 or 8291kHz.
- Transmit to any frequency which will enable other craft to home to the distress location.
- Call to surface craft to render assistance by use of manoeuvres set out below, or otherwise by communication on 2182, 4125kHz or 156.8MHz (VHF channel 16).
- Attempt to establish communication with the aircraft in distress when requested by ATC.
- Before departing from the area, turn off automatic emergency radio equipment.

3.2 Assistance of Surface Craft

3.2.1 To direct a surface craft to distress incident:

- circle the vessel at least once;
- fly across the bow of the vessel at low level while rocking the wings, opening and closing the throttles or changing propeller pitch if possible; and
- head in the direction required.

Note: Visual signals by the surface craft:

ACKNOWLEDGE - red and white vertical striped flag or flashing of a series of 'T's by light.
UNABLE TO COMPLY - square blue and white checkered flag signal or the flashing of a series of 'N's by light.

3.2.2 When assistance is no longer required fly across the stern of the vessel at low level, rocking the wings, opening and closing the throttles or changing propeller pitch if possible.

3.3 Emergency Management Australia (EMA)

- 3.3.1 During relief operations mounted in time of floods, bushfires or other disasters, ground/air signals may be used to indicate requirements.
- 3.3.2 Aircraft engaged by the relevant State Emergency Service to survey the area, will be briefed to watch for emergency signals. Pilots of other aircraft, not involved in the relief operation, should report sightings to the nearest ATS unit.
- 3.3.3 Pilots need to be aware of the importance of indicating the actual signal seen (e.g. Civil Emergency Signal No 3), as an attempt to interpret, the signal may be confusing to those receiving the message.

3.4 Ground/Air Emergency Signals in Use for Australian Civil Emergencies

GROUND - AIR VISUAL SIGNAL CODE FOR USE IN CIVIL EMERGENCIES		
No	Message	Code Signal
1	Require Fodder	FF
2	Require Evacuation	III
3	Power Failure	VI

GROUND - AIR VISUAL SIGNAL CODE FOR USE BY SURVIVORS		
No	Message	Code Signal
1	Require Assistance	V
2	Require Medical Assistance	X
3	Proceeding in this Direction	
4	Yes or Affirmative	Y
5	No or Negative	N
	If in doubt use International Symbol	SOS

Notes:

1. Aldis lamp signals

Red flashes - not understood

Green flashes - message understood.

2. Air Ground Signals

The following signals by aircraft mean that the signals have been understood

a During the hours of daylight - rocking the aircraft's wings

b During the hours of darkness - by flashing the aircraft's landing or navigation lights on or off twice.

3. Lack of the above signal indicates that the message has not been understood.

4. The "GROUND - AIR VISUAL SIGNAL CODE FOR USE BY SURVIVORS" conforms to ICAO and NATO standards.

3.5 Visual Distress Signals - Small Vessels

Either of the two signals shown below may be displayed by small vessels. The signals are for use **ONLY** in the Australian Search and Rescue Area. The signal sheet is rectangular, coloured international orange, with black symbols.

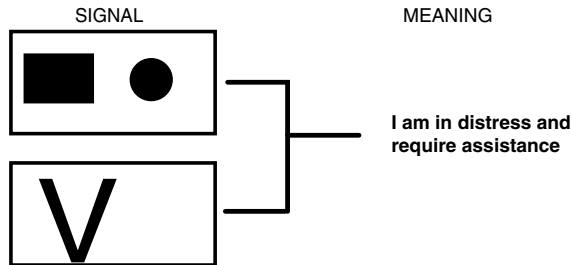

4. SURVIVAL

4.1 Introduction

4.1.1 Alone and injured, people have survived in almost impossible circumstances. The determination to beat the situation and the will to survive is the survivor's strongest weapons. Military SAR will not give up searching for downed aircrew.

4.1.2 The peacetime priorities of survival are listed below:

a. **PROTECTION:** The elements of protection are:

- (i) First Aid - breathing must be restarted within 3 minutes;
- (ii) Clothing;
- (iii) Shelter - in harsh weather a shelter will be required in less than 3 hours; and
- (iv) Fire.

b. **LOCATION:** Most survivors are located within 3 days.

c. **WATER:** In Australia's arid centre water must be found within 3 days.

d. **FOOD:** Survival without food for at least 30 days is possible. Therefore, food is the lowest priority. Food information is contained in the JUNGLE SURVIVAL section.

4.1.3 Basic survival rules are outlined in the following sections:

- a. Location;
- b. First Aid;
- c. Desert Survival;
- d. Sea Survival;
- e. Jungle Survival; and
- f. Cold Weather Survival;

4.1.4 Rapidly adapt to the new situation - **DO NOT WASTE TIME**. Even if SAR is expected quickly develop a plan of action that will assist SAR and improve living conditions. Start working to beat the situation as soon as possible.

4.2 Location

4.2.1 Safety Equipment

4.2.2 When moving always carry location aids and protect them from deterioration. Do not fire pyrotechnics until SAR is sighted. Consider the best use of aids:

- a. survival radios/beacons,
- b. signal mirror,
- c. day/night flares,
- d. rockets,
- e. strobe,
- f. signal panels, and
- g. sea dye marker.

4.2.3 Improvised Aids.

- a. Improve rescue chances by constructing fires and ground signals.
- b. Signal Fires:
 - (i) Initially use campfire
 - (ii) 3 fires 30M apart in line or triangle.
 - (iii) Burn greenery or wreckage to produce smoke during the day

4.2.4 Ground Signals.

Ground signals should be 1M wide and 6M long and must contrast with environment by using angles, colour, reflective material and shadow.

4.3 **First Aid**4.3.1 **FIRST AID KITS IN AIRCRAFT: LOW CAPACITY AIRCRAFT LESS THAN 30 PAX**

Recommended Contents	
Quantity	Item
1	First Aid Manual
1	Airway Tube
1	4" Scissors
5	Safety Pins
1	Single Edge Blade
2 pair	Disposable Gloves
1	Triangular Bandage
3	White Open Weave Bandages 7.5CM
3	Plain Wound Dressings No. 9
1 pkt	Elastoplast Miscellaneous Dressings
10	Sterile Strip Sutures
1	Micropore 2 inch tape
2	Eye Pads No. 16
2	Crepe Bandages 6"
1 pkt	White Lint Gauze
1 pkt	15G Cotton Wool
2 pcs	Vaseline Impregnated Gauze
1	150ML Eye Irrigation Liquid
2 pkts	Savlodil Antiseptic Solution
1 tube	Antiseptic Cream
1 tube	Calamine Cream 50G
20	Panadeine CO Tablets
1 pkt	Band-Aids

4.3.2 **First Aid - Adults**

- Reassure the casualty.
- Always monitor ABC/level of consciousness in every case.
- Give Oxygen.
- Aviation Rescue Fire Fighting provide: First Aid response, Oxygen & Defibrillation.

4.3.3 **The Chain of Survival**

- Early access to emergency services
- Early CPR to buy time for defibrillation
- Early defibrillation to revert heart back to a normal rhythm
- Early advanced life support for drug administration and advanced airway management

4.3.4 **DRSABCD****Danger**

Ensure the area is safe for yourself, others and the patient.

Response

Check for response.

Send For Help

Dial Triple Zero (000) immediately.

Airway

Check and clear airway.

Breathing

Look, listen and feel for breathing.

CPR

30 compressions to 2 breaths at 100 compressions/min.

Defibrillation

If Automated External Defibrillator (AED) is available, follow voice prompts.

Monitor pulse, respirations and maintain ABC.

4.3.5 **Head Injury**

a. Lay with injured side down, if possible

b. Do not give drugs, water or food

4.3.6 **Stop Bleeding**

a. Apply direct pressure to wound with gloved hands / bandages;

b. If direct pressure insufficient, use a broad bandage to apply constrictive pressure at top of effected limb.

c. Do not remove embedded objects. Use a ring pad around protrusions.

d. Elevate the limb unless broken;

e. Tourniquets not used.

4.3.7 **Chest Injury**

a. Cover sucking chest wounds with a non porous bandage sealed on three sides (acts as one-way valve). If casualty becomes worse, remove the non-porous bandage;

b. Immobilise unstable chest by circumferential bandaging - firm not tight.

c. Posture casualty: Half-sitting with injured side down, if possible.

d. Do not give pain killers

4.3.8 **Wounds**

a. Use clean / sterile dressings

b. Do not remove embedded objects, use a ring pad around protrusions

c. Do not touch or replace internal organs. Cover with a sterile, wet pad (or gladwrap), do not apply pressure.

4.3.9 **Fractures:**

Support and Immobilise

a. Arms: Splint and strap to body;

b. Legs: Splint and strap together.

4.3.10 **Burns:**

Cool and Cover

a. Cool with water - 20 minutes

b. Do not remove material from wound

c. Cover with wet, sterile / non-stick dressing (or gladwrap)

4.3.11 **Shock:**

Casualty looks pale, skin feels cold and clammy

a. Lay conscious casualty on back, elevate legs

b. Maintain normal body temperature

c. Rest, reassure, no alcohol or drugs

4.3.12 **Minor Wounds**

Treat all minor wounds including scratches and cuts (prevent infection)

4.3.13 **Dehydration:**

Dark / pungent urine requires an increase in fluid intake

a. Rest in shade and cool

b. Drink fluids (water is best) - not alcohol / caffeine

4.4 **Acute Care**4.4.1 **Snakebite:**

a. Victim must remain calm. Use pressure Immobilisation Technique.

b. Firmly bandage whole limb. Start atop bite site then bandage limb upwards.

c. Bandage firm but not so tight as to cut off circulation.

d. Do not allow casualty to move - must remain still.

e. Splint the limb, immobilising as you would a fracture.

f. Monitor ABC / level of consciousness & circulation to effected limb.

-
- 4.4.2 Carbon Monoxide (CO) Poisoning:
- Remove casualty to fresh air - Casualties skin colour may sometimes look normal;
 - If available give concentrated oxygen;
 - Symptoms may include; headache, nausea, drowsiness, confusion;
 - CO is a colourless, odourless, tasteless gas.
- 4.5 **Desert Survival**
- 4.5.1 Immediate Action:
- Activate ELT immediately: and
 - Rest in solid shade 0.3M above ground. (Do not use aircraft interior, if no shade is available then erect a shelter)
- 4.5.2 **Desert Survival Rules:**
- Note: With temperatures above 30DEG C most of the body's water loss is through sweating. The body sweats to cool itself. Survivors must reduce body heat gains to minimise sweating and then procure water at night. Night temperatures may be cold.*
- Rest in shade 0.3M above or 75CM below ground. Avoid gaining heat from ground conduction or hot air layer above ground.
 - Do essential work when sun down and temperature has dropped to about 20DEG C;
 - Stay fully clothed. A single loose layer of clothing minimises heat gains and maximises sweat cooling;
 - Ration water to stay hydrated. Check colour of urine. Dehydrating will impair performance and does not decrease water consumption;
 - Eat only carbohydrates and only if water is available. Avoid greasy or fatty foods;
 - Do not travel unless sure of water. Walking in sun instead of resting in shade will at least halve survival time.
- 4.5.3 **Water Procurement:**
- Sterilise all water sources except plastic bag procurement methods. Instructions for setting up water procurement devices are contained with water transpirator bags.
- TRANSPIRATOR BAGS: Best water procurement device, set up immediately;
 - DESERT STILL: Set up at night;
 - DEW/RAIN;
 - PLANTS: Unreliable source, look for damp patches on trees and insect life; and
 - GROUND WATER: Some indicators are terrain, birdlife, vegetation, animal tracks and insects. Water may exist in rock pools in hills as well as underground, in low lying creek areas.
- 4.6 **Sea Survival**
- 4.6.1 Immediate Action:
- Secure and deploy raft.
 - Activate ELT immediately.
 - Gather useful equipment and board raft (dry if possible).
 - Roll call - locate missing persons.
 - Cut adrift, tie rafts together on 8M line and secure one man to raft.
 - Check raft, adjust sea anchor length to half distance between waves, and in cold weather inflate floor and canopy.
 - Retrieve, secure (to prevent loss if capsized) and inventory equipment.
 - Develop a plan of action.
 - Elect a leader, allocate duties.
- 4.6.2 Allocation of Duties
- A fully loaded liferaft is cramped and uncomfortable.*
- Rotate duties.
 - Exercise, keep occupied and work as a team to minimise discomfort.
 - Allocation of duties should include, lookouts with location aids, raft maintenance, maintaining water devices and food procurement.
 - Plan pyrotechnic operations to avoid damaging raft.
- 4.6.3 Essential Rules For Sea Survival - If Short of Water.
- Ration water to stay hydrated. Check colour of urine, dehydration impairs performance and does not decrease water consumption. Hold reliable water sources in reserve;
 - In hot areas wear clothes dampened during day and remain in shade. This will halve water loss by minimising sweating. Protect eyes and skin against sun. Do not exit raft to swim;
-

- c. Fish should not be eaten if short of water, sun dry until rain provides sufficient water. Fish that have an unusual shape, features or skin instead of scales should not be eaten;
 - d. Avoid seasickness. Use seasick tablets, seasickness will wear off.
 - e. Do not drink seawater, urine or the blood of sea birds.
- 4.6.4 Keep Raft Dry,
Avoid immersion, foot and raft sores by regularly changing position.
- 4.6.5 Discourage Predators
- a. Do not trail attractive items.
 - b. Discard waste well away from raft at night.
- 4.6.6 Travel.
A small amount of control is possible by adjusting raft for wind or currents. Deploy sea anchor to travel with the current or retrieve it to travel with the wind.
- 4.7 **Jungle Survival**
- 4.7.1 Immediate Action
- a. Orientate and rendezvous with crew. (Stay fully clothed when moving in jungle);
 - b. If wreckage is hidden, move to nearby clearing to assist SAR.
 - c. activate ELT immediately.
- 4.7.2 Essential Rules For Jungle Survival:
- a. Protection - water and food will be readily available in the jungle but location by SAR will be difficult.
 - b. Set up location aids. Select sites to give location aids best possible ranges. Build fires with smoke to penetrate canopy (refer to "Improvised Aids in Location" section).
 - c. Sterilise water and animal food. Boil water for 5 minutes or use sterilising tablets. Discard animal food that shows any sign of disease. Always cook animal food to kill parasites.
 - d. If food is not recognised as safe, apply edibility test.
 - (i) Discard stinging plants, fungi, plants with milky sap or with the smell of almonds or peaches.
 - (ii) Discard food that irritates sensitive skin areas such as inside of elbow after 5 mins.
 - (iii) Chew a teaspoon quantity and spit out, discard if reaction occurs in 5 minutes.
 - (iv) Eat a teaspoon quantity and discard if reaction occurs in 4 hours and
 - (v) Eat two teaspoons quantities-plant is safe if no reaction occurs in 4 hours.
 - e. Do not travel unless habitation seen nearby or search scaled down. Travel rate can be as slow as 500M/HR. Creeks and ridgelines will give fastest travel. Leave messages at crashsite and camp and blaze trail if travelling.
- 4.7.3 Shelters
- a. A shelter will be required in rain or if overnighing.
 - b. Two taut separated layers of parachute or natural thatching at 60DEG will provide a waterproof shelter.
 - c. A single taut layer of parachute at 45DEG will provide a shower proof shelter.
 - d. Keep off the ground to avoid insects and parasites.
- 4.8 **Cold Weather Survival**
- 4.8.1 Immediate Action:
- a. Adjust clothing - protect hands and head.
 - b. Shelter from high winds. (Aircraft interior will provide windproof shelter but little thermal protection).
- 4.8.2 Essential Rules For Cold Weather Survival
- a. A drop in body core temperature will mentally affect the survivor, impairing work. The onset is difficult to detect and shivering should be taken as the first warning that heat losses must be minimised. Dressed only in flying clothing, survival chances are good, if a thermal windproof shelter is constructed quickly.
 - b. Keep clothing dry. Heat loss from wet clothing is 20 times greater than dry.
 - c. Remove clothing before commencing work to avoid sweating;
 - (i) Do not let snow melt on clothing;
 - (ii) Keep feet dry by preventing snow entering boots;
 - (iii) Loosen clothing to trap air.
 - (iv) Use a windproof layer to stop wind chill.
-

- d. Construct a shelter. If rescue is delayed then the windproof shelter used in the immediate action must be improved with insulation to provide thermal protection.
 - (i) 25CM of snow will provide good insulation.
 - (ii) Rafts, sound proofing or branches will provide insulation from ground.
 - (iii) A one man snow cave can be built in one hour.
 - (iv) In bad weather without a windbreaker an enclosed shelter is more useful than a fire.
- e. Maintain location aids.
 - (i) Keep battery powered equipment warm.
 - (ii) The insulation of a snow shelter will prevent survivors hearing SAR aircraft. Windproof ground signals should be constructed and kept free of snow.
- f. Do not travel unless habitation seen nearby or search scaled down. Travel is strenuous and as slow as 4KM/day. Crevasses and avalanches are hazards in ice and mountainous country.

4.8.3 Medical Hazards.

When outdoors, work in pairs. Observe partner to detect onset of cold injuries.

- a. Hypothermia. (Lowering of body core temperature). Hypothermia can occur in above zero temperatures. The symptoms are incoherence, slowing down, stumbling and weakness. These symptoms may be mistaken for fatigue. To treat hypothermia protect casualty from wind change wet clothing for dry and use body warmth and insulation to warm.
- b. Frostbite. The symptoms are tingling numbing sensation with waxy white appearance. Gently rewarm areas using body heat if nothing else is available. If deep frostbite has occurred leave frozen until rescued.
- c. Carbon Monoxide Poisoning. Ventilate shelters where a stove is used with two 6CM holes in door and roof. Do not light fires inside enclosed shelters.
- d. Snow Blindness. Prevent too much light entering eyes by using sunglasses or eyeshields. Keep eyes covered to recover from snow blindness.
- e. Dehydration. Cold will decrease thirst sensation. Check frequency and colour of urine to avoid unintentional dehydration. To maintain body core temperature drink warm water.

4.8.4 Shelters

The Lean-to with fire and reflector will provide good protection in wooded temperate conditions. An improvised igloo can be made by covering branches, rafts etc., with a parachute and covering with 25CM of snow, letting set and then removing the core. The A-Frame must be modified with 25 CM of snow cover to provide thermal protection. The quickest shelter to build without a shovel is the snow cave. Probe before building to check snow depth. Smooth walls to prevent dripping and construct a cold sump. Stay dry when digging. A snow trench may be constructed with a saw in hard snow.

5. **INTERCEPTION AND AIR DEFENCE IDENTIFICATION ZONE (ADIZ) PROCEDURES**

5.1. See *AIP ENR 1.12* for.

- a. the procedures and visual signals which apply over the territory and territorial waters of Australia in the event of interception of an ACFT, and
- b. the general rules and procedures used to identify air traffic entering any designated ADIZ under the control of Australia.

6. **ROYAL FLYING DOCTOR SERVICE (RFDS) HF RADIO AND SATCOM NETWORK**

- 6.1. Aircrew requiring in-flight medical advice may attempt contact with the RFDS on the following HF frequencies or SATCOM numbers. Initial contact may be with a duty operator who will facilitate communication with medical personnel.

Base	Organisation	Telephone Contact	Frequencies
Jandakot	RFDS Western Operations	08 9417 6389	N/A
VJD Alice Springs	RFDS Central Operations	08 8648 9555	N/A
VNZ Port Augusta	RFDS Central Operations	08 8648 9555	2020, 4010, 6890, 8165
VJC Broken Hill	RFDS South Eastern Section	08 8088 1188	2020, 4055, 6920
VJN Charleville	RFDS Queensland Section	07 4654 1433	2020, 4980, 6845
VJI Mt Isa	RFDS Queensland Section	07 4743 2802	2020, 5110, 6965
VJN Cairns	RFDS Queensland Section	07 4040 0500	2020, 2260, 5145, 7465
VZX Firefly	Penta Comsat	02 6559 1888	call
RFDS website: www.flyingdoctor.org.au			

This page is intentionally blank.